

RevNo	Revision note	Date	Signature	Checked
0	GENERAL REVISION		IP	IP

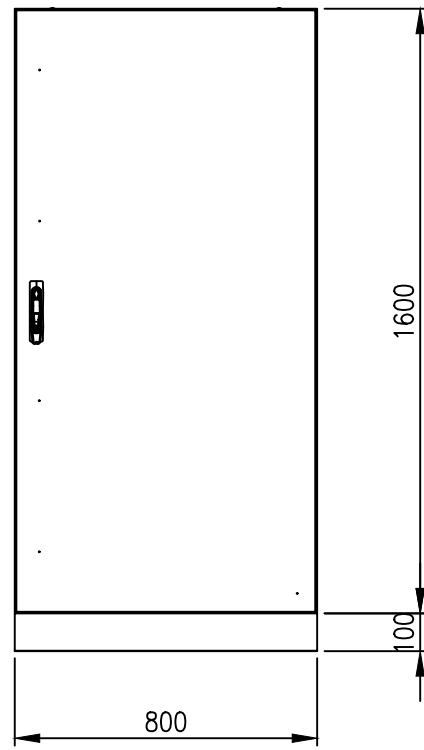

TOP VIEW



FRONT VIEW

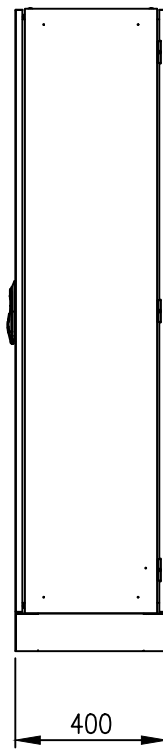

SIDE VIEW

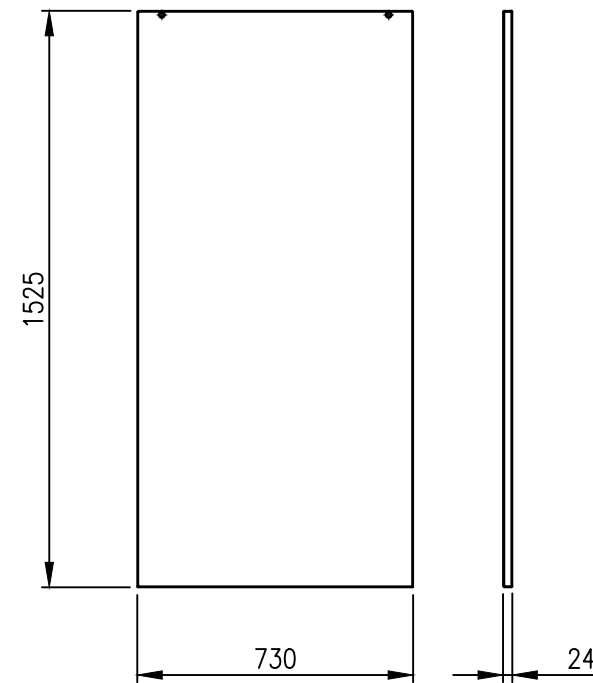

DEVICE MOUNTING PLATE

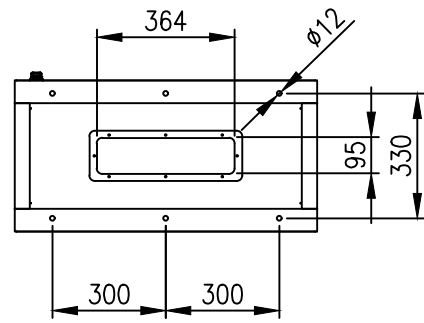
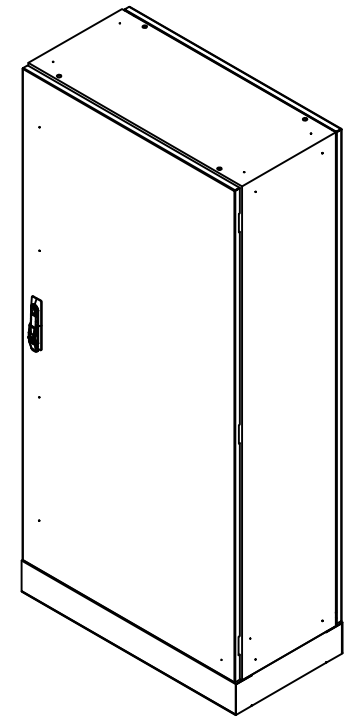

BOTTOM VIEW

MATERIAL
 BODY: 1.5mm 304 STAINLESS STEEL
 DOOR: 1.5mm 304 STAINLESS STEEL
 DEVICE PLATE: 1.5mm GALV STEEL
 SEAL: POLYURETHANE

PROTECTION: IP66 IK10, NEMA4x
STANDARD: IEC62208, IEC/EN/AS60529

© IP ENCLOSURES 2022.
 THIS DRAWING SHALL NOT BE COPIED OR REPRODUCED
 WITHOUT AUTHORISATION FROM IP ENCLOSURES.
 www.ipenclosures.com.au

Itemref	Quantity	Title/Name, designation, material, dimension etc			Article No./Reference	
Designed by IP	Checked by IP	Approved by - date 28/09/22	Filename IP-304-1608040	Date 28/09/22	Scale 1:20	
			1600x800x400 304SS ENCLOSURE			
			IP-304-1608040	Edition 0	Sheet 1/1	