

RevNo	Revision note	Date	Signature	Checked
0	GENERAL REVISION		IP	IP

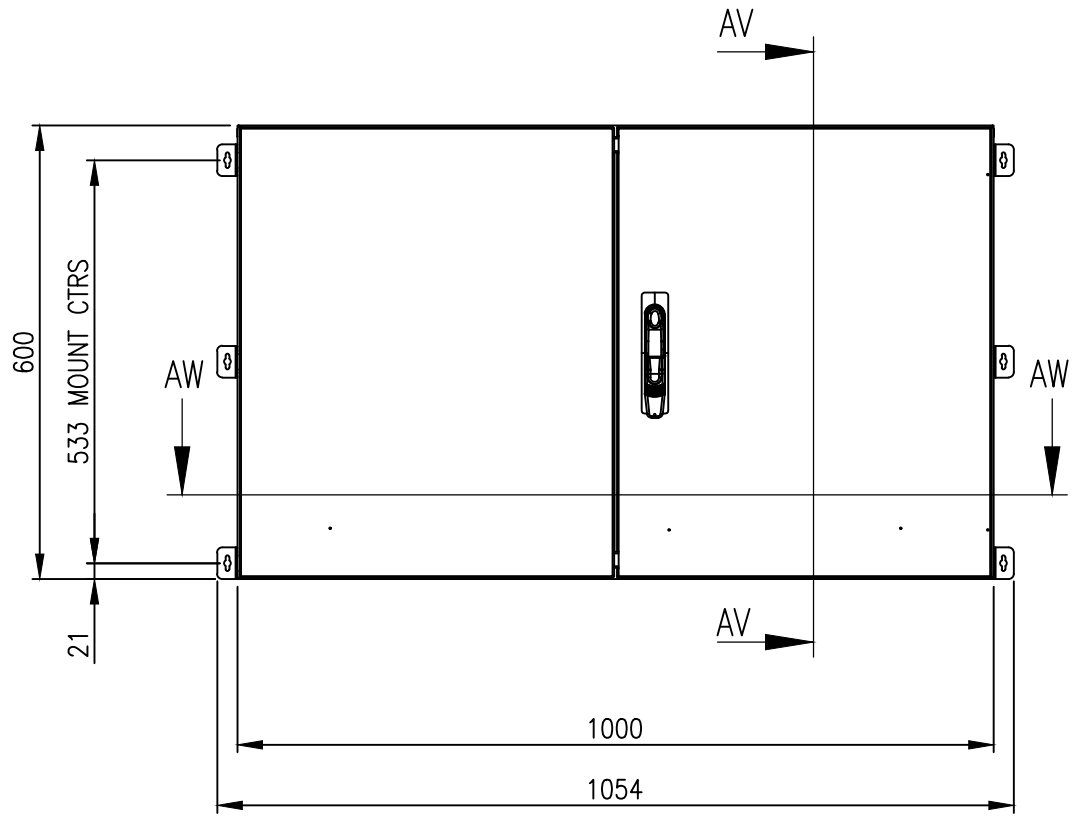

FRONT VIEW

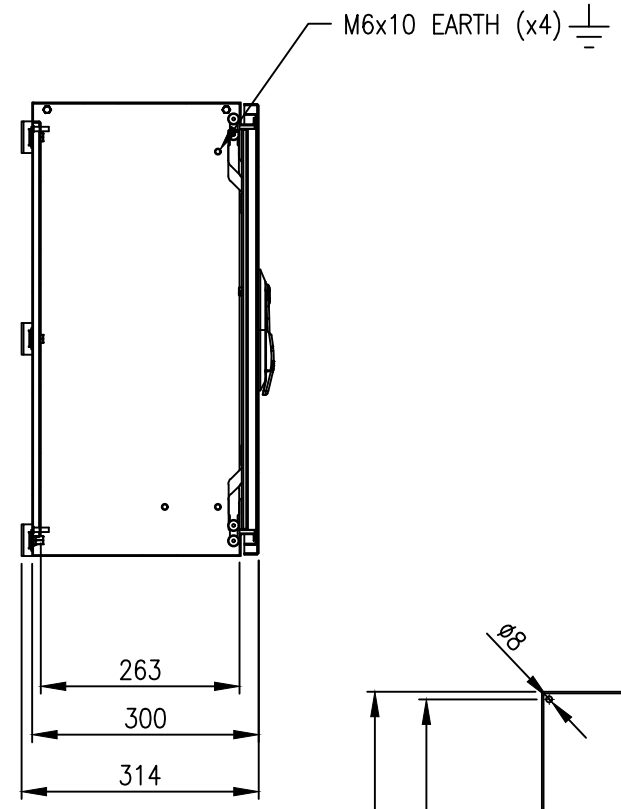

SECTION AV-AV

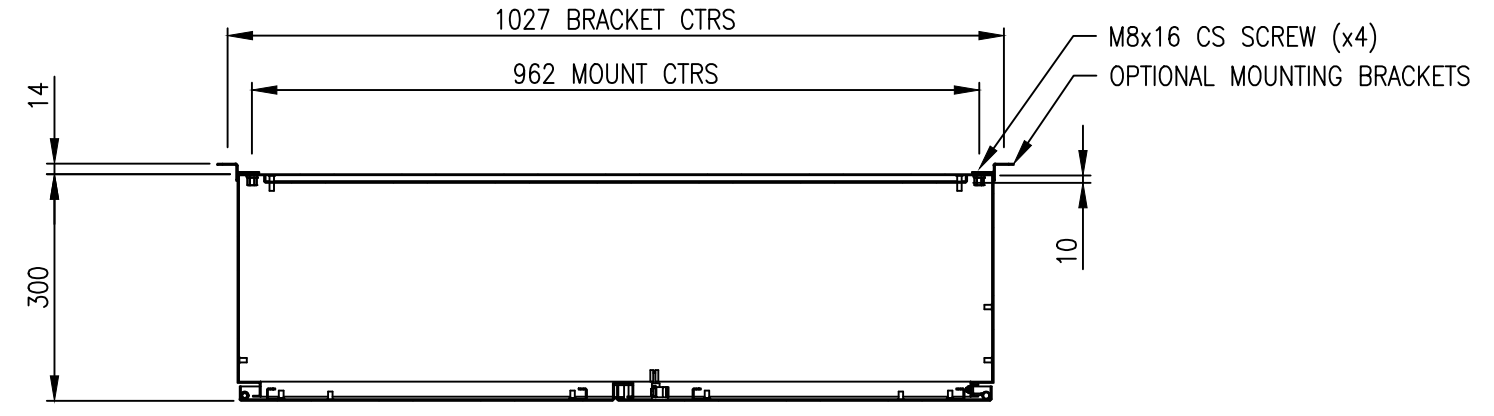
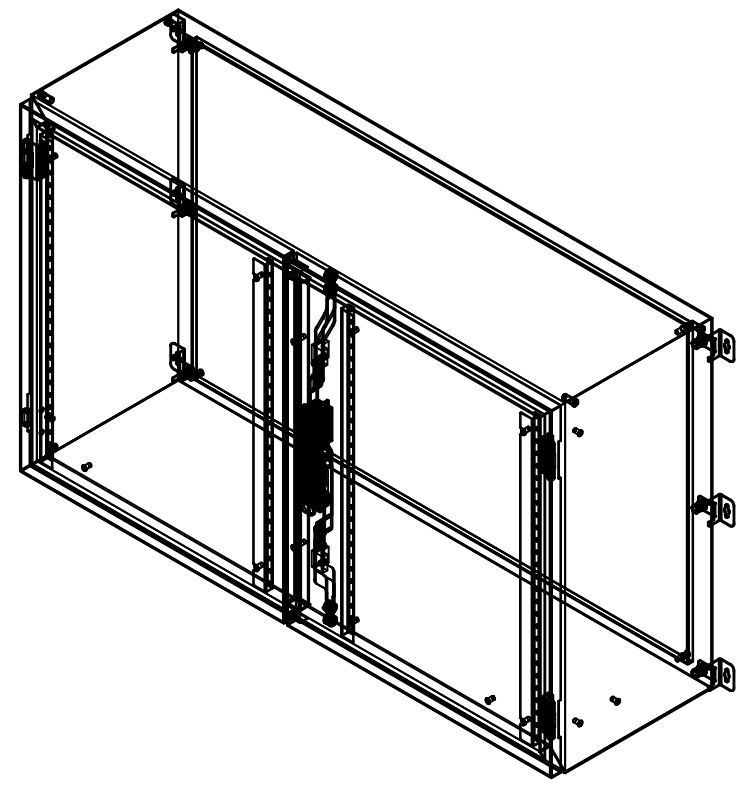

SECTION AW-AW

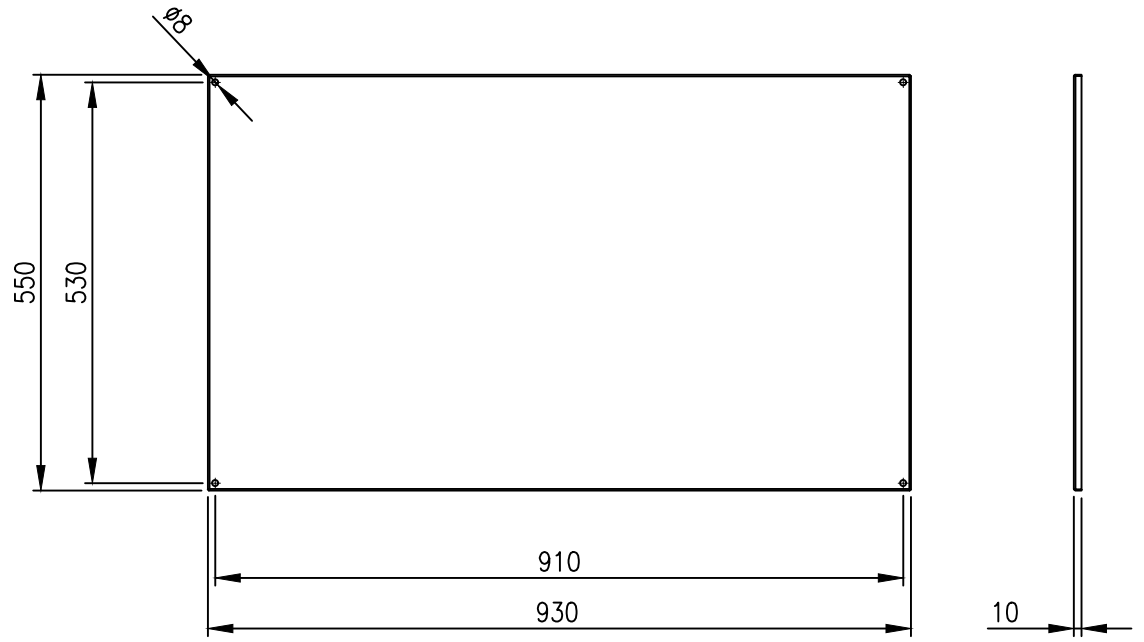

DEVICE MOUNTING PLATE

MATERIAL
 BODY: 1.5mm 304 STAINLESS STEEL
 DOOR: 1.5mm 304 STAINLESS STEEL
 DEVICE PLATE: 1.5mm GALV STEEL
 SEAL: POLYURETHANE

PROTECTION: IP55 IK10, NEMA4x
STANDARD: IEC62208, IEC/EN/AS60529

© IP ENCLOSURES 2022.
 THIS DRAWING SHALL NOT BE COPIED OR REPRODUCED
 WITHOUT AUTHORISATION FROM IP ENCLOSURES.
 www.ipenclosures.com.au

Itemref	Quantity	Title/Name, designation, material, dimension etc	Article No./Reference
IP	1	600x1000x300 304SS ENCLOSURE	IP-304-L6010030
Designed by	Checked by	Approved by - date	Filename Date Scale
IP	IP	28/09/22	IP-304-L6010030 28/09/22 1:10
Edition			Sheet
0			1/1