

RevNo	Revision note	Date	Signature	Checked
0	GENERAL REVISION		IP	IP

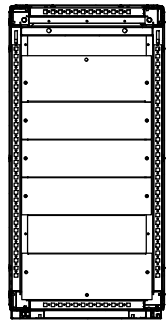

SECTION E-E

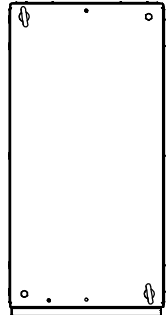

TOP VIEW

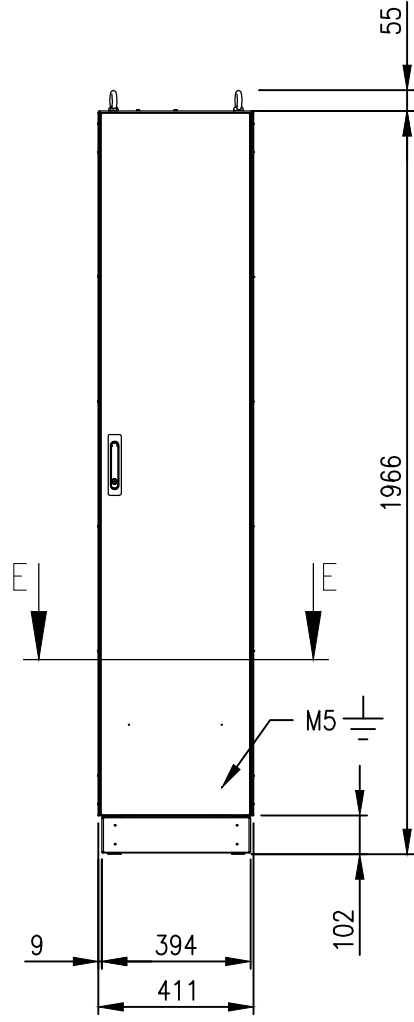
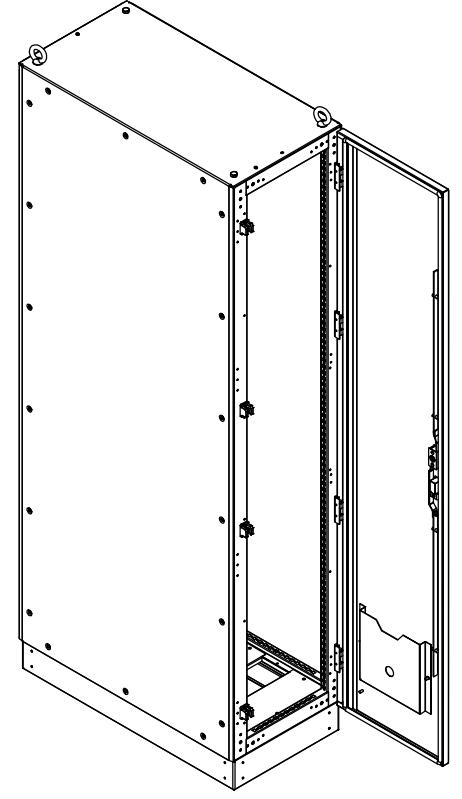

FRONT VIEW (ASSEMBLY)

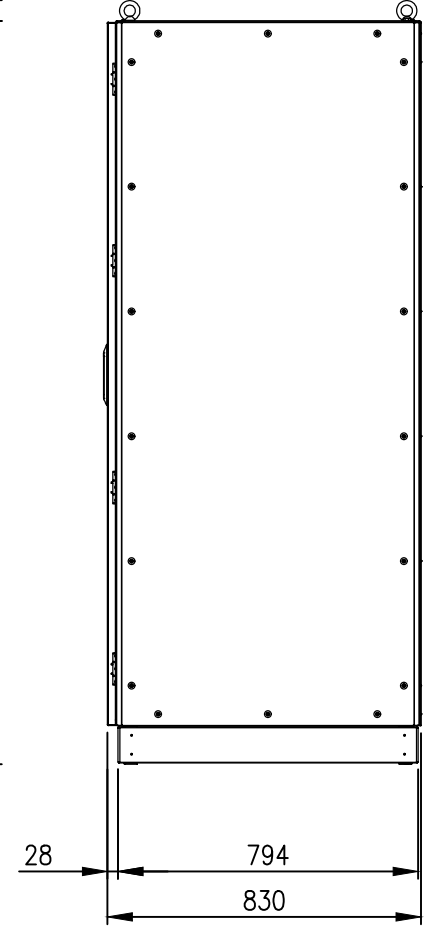

SIDE VIEW

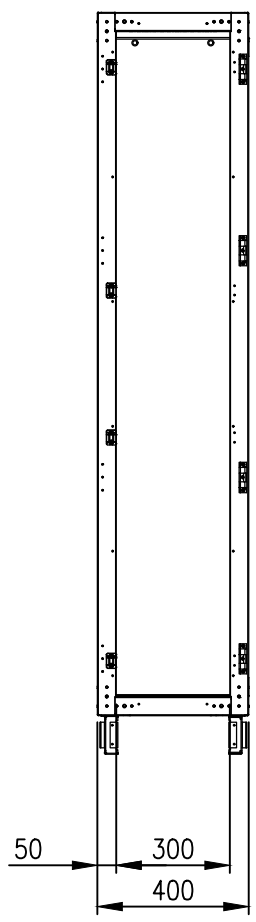

FRONT VIEW (PANELS REMOVED)

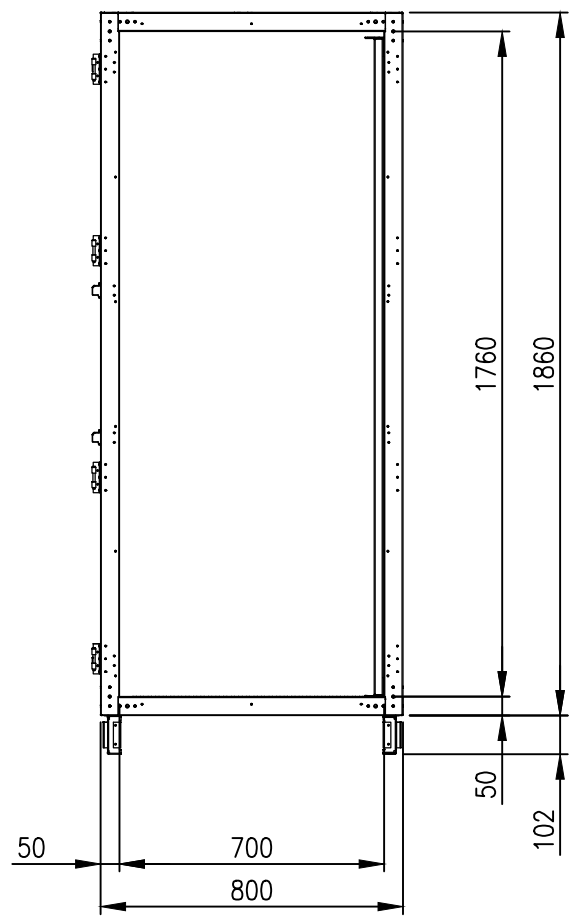

SIDE VIEW (PANELS REMOVED)

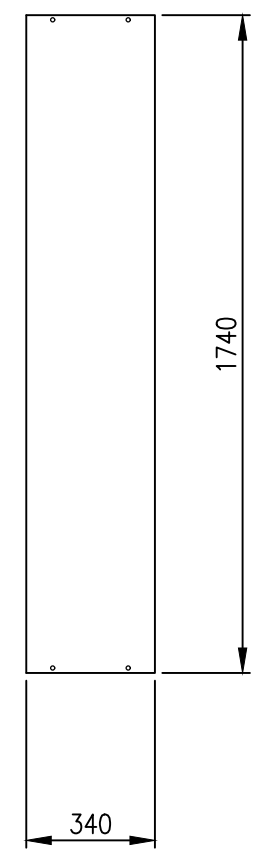

DEVICE MOUNTING PLATE

MATERIAL
 MAIN FRAME: 2.0mm 304 STAINLESS STEEL PROFILE
 PANELS: 1.2mm 304 STAINLESS STEEL
 DOOR: 2.0mm 304 STAINLESS STEEL
 MOUNTING PLATE: 2.0mm GALVANISED STEEL SHEET
 SEAL: EPDM

PROTECTION: IP55 IK10
 STANDARD: IEC62208, IEC/EN/AS60529
 ORDERING INFORMATION:
 - ENCLOSURE: IP-MFSS1864080
 - SIDE PANEL: IP-MFSSP18680
 - MOUNTING PLATE: IP-MFSM18640
 - BASE: IP-MFSSB4080

© IP ENCLOSURES 2022.
 THIS DRAWING SHALL NOT BE COPIED OR REPRODUCED
 WITHOUT AUTHORISATION FROM IP ENCLOSURES.
 www.ipenclosures.com.au

Itemref	Quantity	Title/Name, designation, material, dimension etc	Article No./Reference
IP	1	1860x400x800 304SS FREESTANDING	IP-304-MFSS1864080
IP	1	IP-304-MFSSP18680	IP-304-MFSSP18680
IP	1	IP-MFSM18640	IP-MFSM18640
IP	1	IP-MFSSB4080	IP-MFSSB4080



1860x400x800 304SS FREESTANDING
 IP-304-MFSS1864080
 Edition 0
 Sheet 1/1