

RevNo	Revision note	Date	Signature	Checked
1	GENERAL REVISION	9/7/19	IP	IP

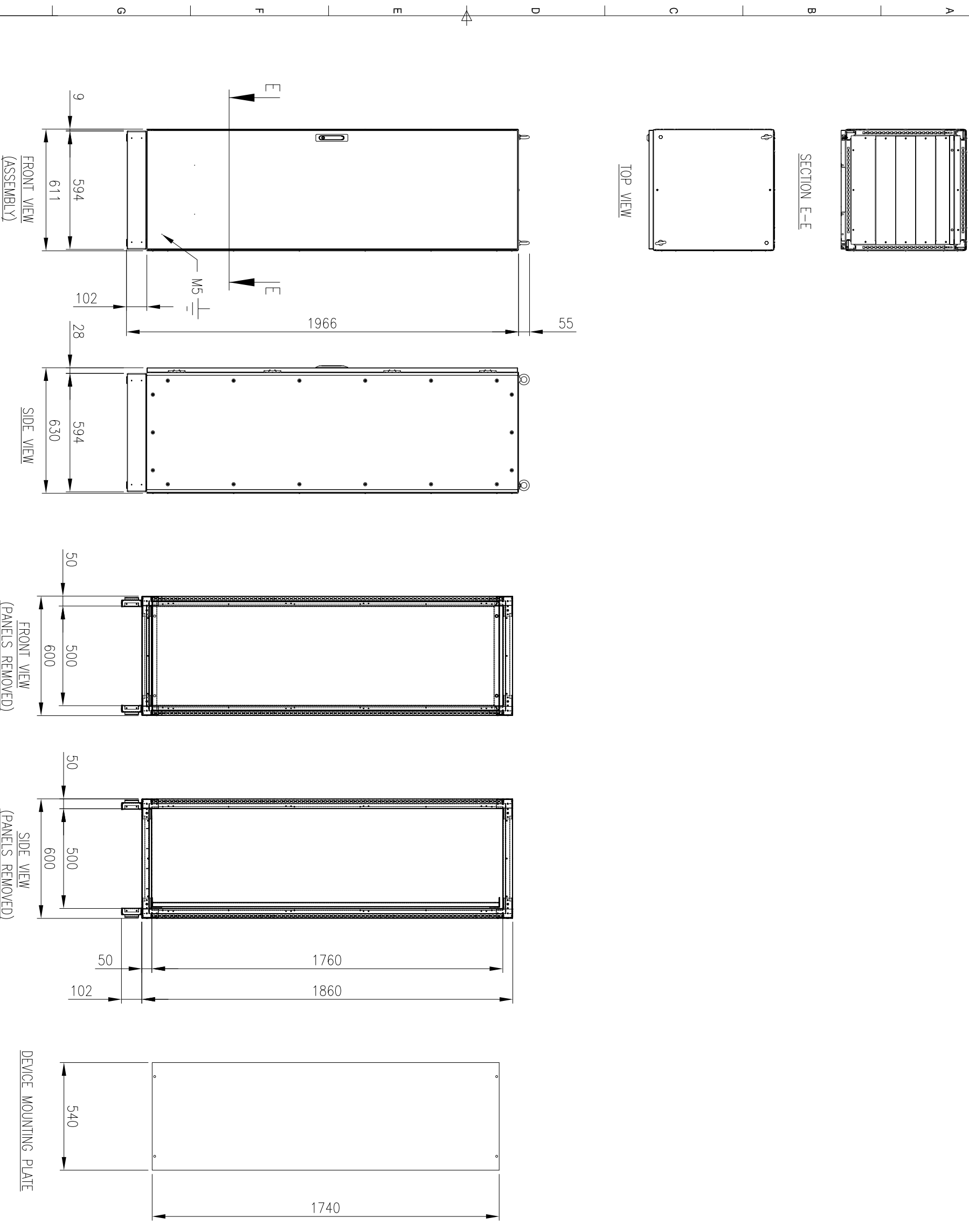
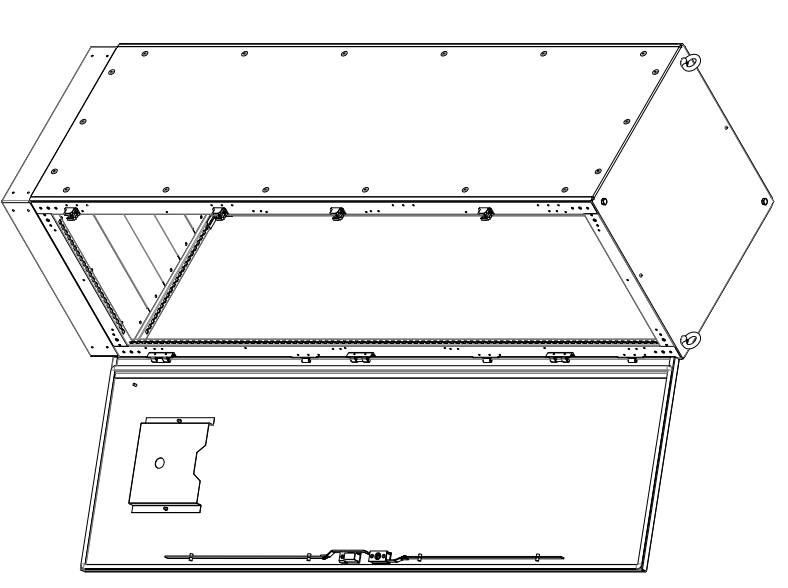

MATERIAL

MAIN FRAME: 2.0mm GALVANISED STEEL PROFILE

PANELS: 1.2mm POWDERCOATED GALVANISED SHEET

DOOR: 2.0mm POWDERCOATED GALVANISED STEEL

MOUNTING PLATE: 2.0mm GALVANISED STEEL SHEET

SEAL: EPDM

SURFACE TREATMENT: POWDER-COAT 80-120micron

STANDARD COLOUR: RAL7035

PROTECTION: IP55 IK10

STANDARD: IEC62208, IEC/EN/AS60529

ORDERING INFORMATION:

- ENCLOSURE: IP-MFS1866060
- SIDE PANEL: IP-MFSP18660
- MOUNTING PLATE: IP-MFSM18660
- BASE: IP-MFSB6060

© IP ENCLOSURES 2017.
THIS DRAWING SHALL NOT BE COPIED OR REPRODUCED
WITHOUT AUTHORISATION FROM IP ENCLOSURES.
www.ipenclosures.com.au

Item#	Quantity	PartName, designation, material, dimension etc.	Article No./Reference	Scale
IP		1860x600x600 STEEL FREESTANDING		1:20
IP		IP-MFS1866060		1/1