

INNER DOOR | 316 STAINLESS STEEL | WALL MOUNTED 1200H x 1200W

The IP Enclosures ID Range of 316 stainless steel inner door escutcheons are designed and manufactured to easily fit into any IP Enclosures wall mounted electrical enclosure without drilling. Inner Doors are tool lockable.

Material:

- Frame: 1.5mm Grade 316 stainless steel
- Door Panel: 1.5mm Grade 316 stainless steel

Lock: Grade 316 stainless steel 8mm square drive quarter turn lock

Clearance/Distance Dimensions:

- Inner Door to Outer Door: 68mm
- Inner Door to Mounting Plate:
 - (Enclosure with 300 Depth): 217.2mm
 - (Enclosure with 400 Depth): 317.2mm

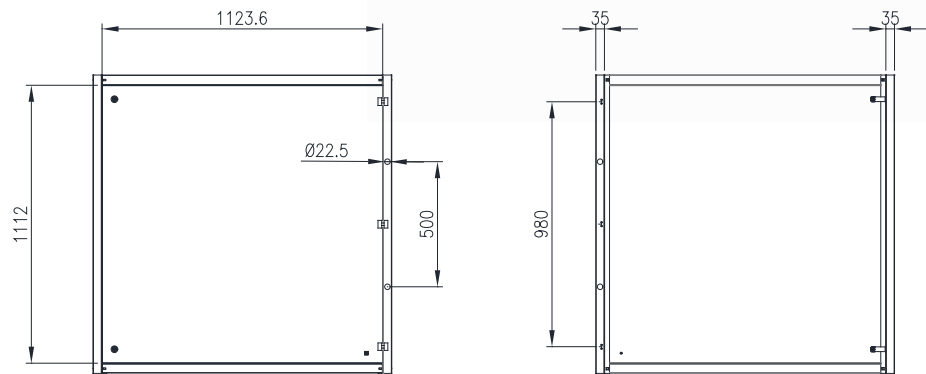

FRONT VIEW

REAR VIEW

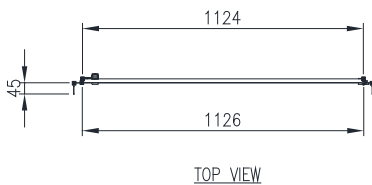

TOP VIEW

