

SECTION AV-AV

FRONT VIEW

RIGHT SIDE VIEW

SECTION AU-AU

GASKET

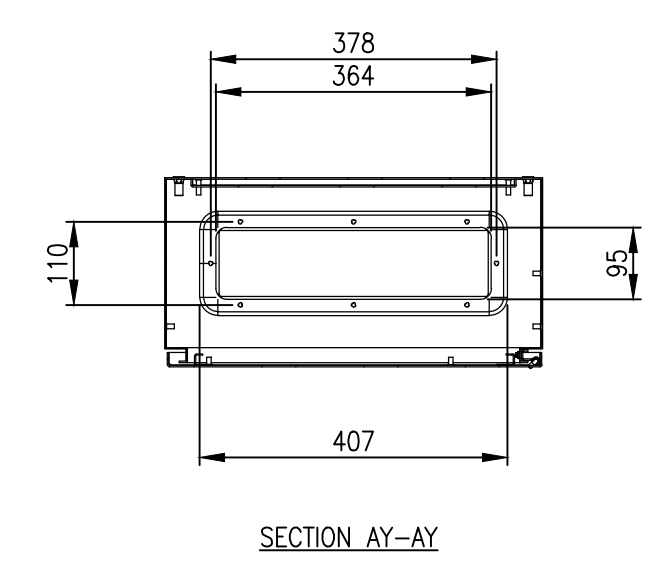

SECTION AY-AY

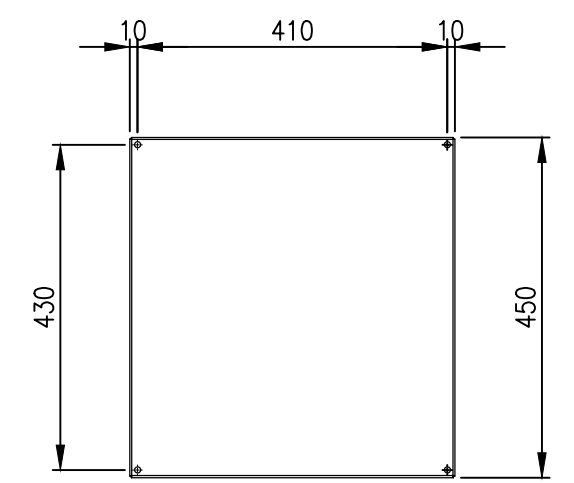

MOUNTING PLATE  
(PAINTED TO RAL9010)

**MATERIAL**  
 BODY: 2.0mm GALVANISED STEEL SHEET  
 DOOR: 2.0mm GALVANISED STEEL SHEET  
 MOUNTING PLATE: GALVANISED STEEL SHEET  
 GLAND PLATE: 2.0mm GALVANISED STEEL SHEET  
 SEAL: POLYURETHANE

PROTECTION: IP66 IK10, NEMA 4  
 STANDARD: IEC62208, IEC/EN/AS60529

© IP ENCLOSURES 2022.  
 THIS DRAWING SHALL NOT BE COPIED OR REPRODUCED WITHOUT  
 AUTHORISATION FROM IP ENCLOSURES.  
 www.ipenclosures.com.au

Itemref	Quantity	Title/Name, designation, material, dimension etc	Article No./Reference
Designed by IP	Checked by IP	Approved by - date 29/07/22	Filename IP-SSR50525-HD-OR
Date 29/07/22	Scale 1:10	500x500x250 HD STEEL SLOPING ROOF ENCLOSURE	
IP-SSR50525-HD-OR		Edition 0	Sheet 1/1